

92  
01  
WEST

UNIT 1

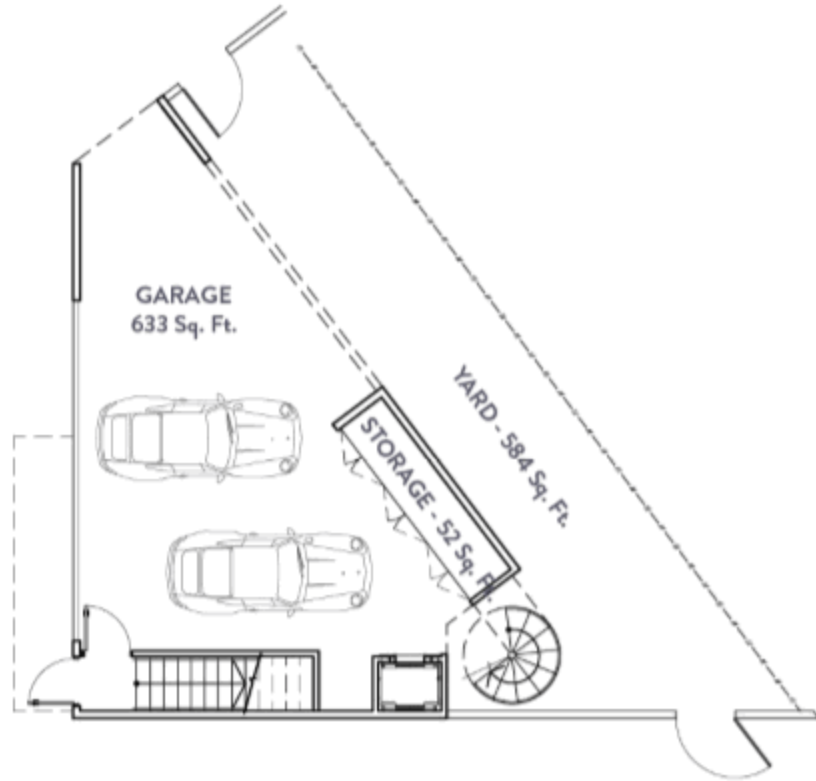

LEVEL 0

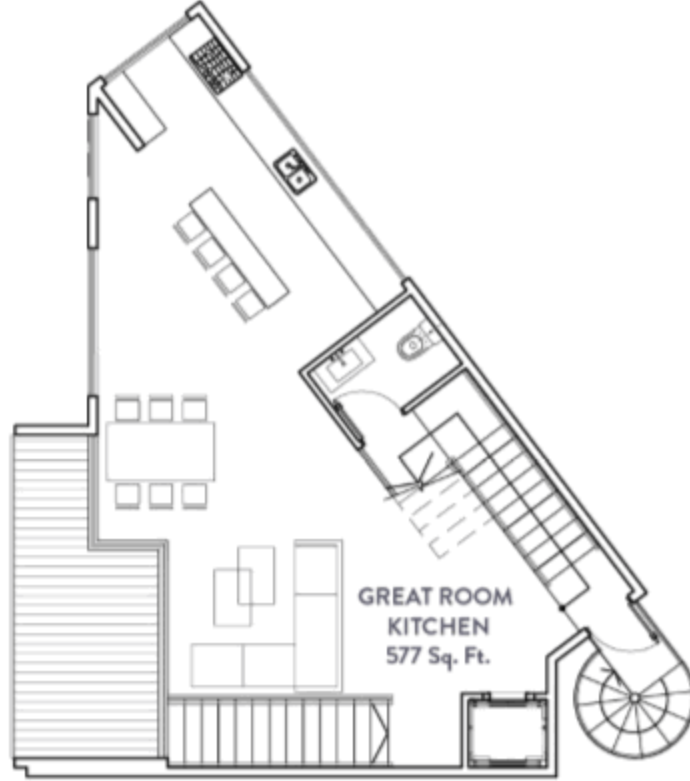

LEVEL 1



LEVEL 2



LEVEL 3

UNIT	BEDROOM	BATH	GARAGE	AIR CONDITIONED	1ST FLOOR TERRACE	3RD FLOOR BALCONY	TOTAL AREA	BACKYARD
1	3	4	820	2,350	120	100	3,390	590



92  
01  
WEST

UNIT 2

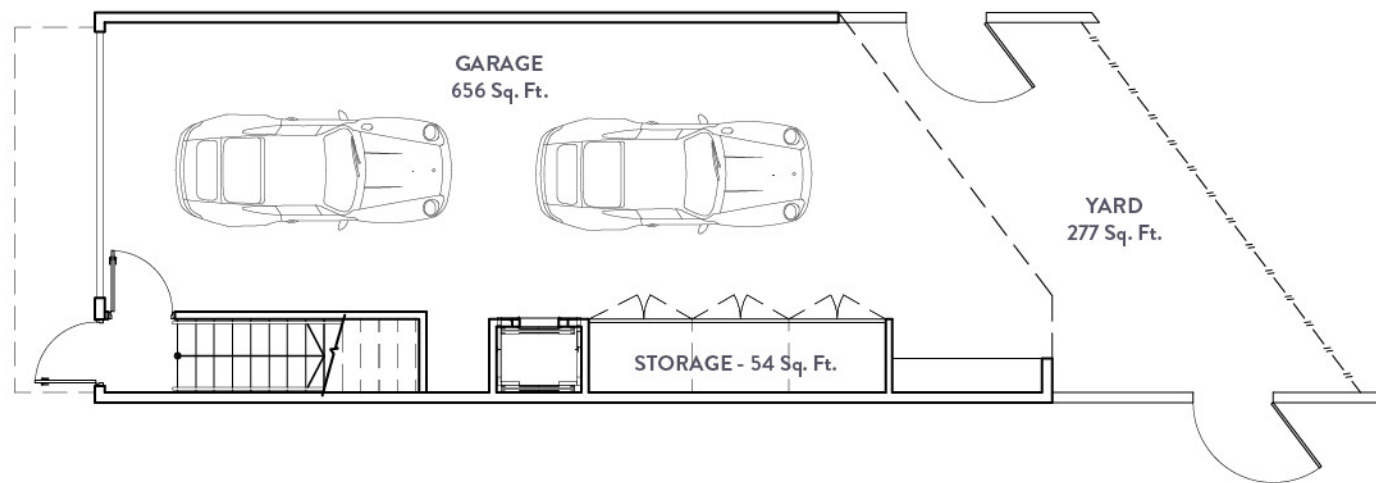

LEVEL 0



LEVEL 1

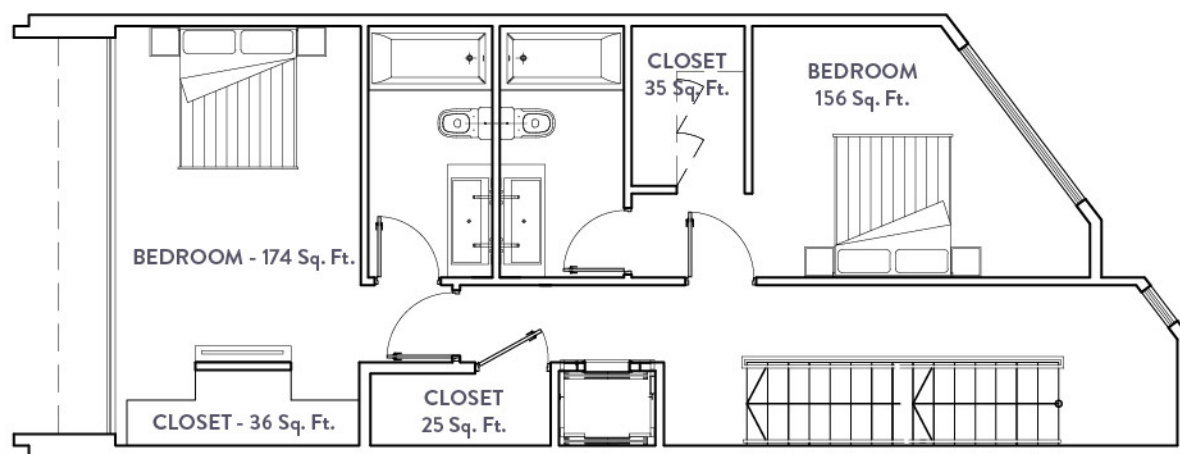

LEVEL 2

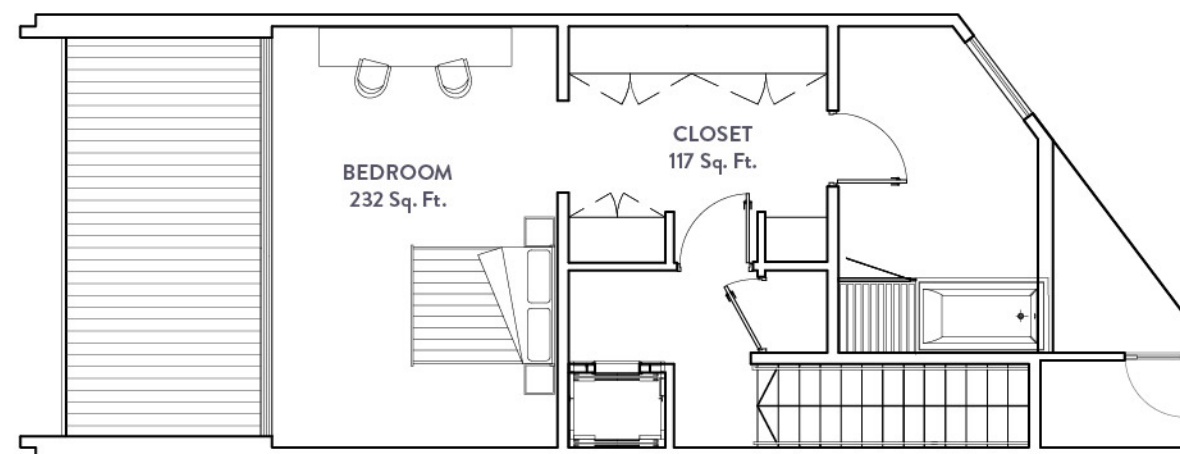

LEVEL 3

UNIT	BEDROOM	BATH	GARAGE	AIR CONDITIONED	1ST FLOOR TERRACE	3RD FLOOR BALCONY	TOTAL AREA	BACKYARD
2	3	4	840 Sq. Ft.	2,310 Sq. Ft.	150 Sq. Ft.	160 Sq. Ft.	3,460 Sq. Ft.	230 Sq. Ft.



**92  
01**  
WEST

**UNIT 3, 5 & 7**

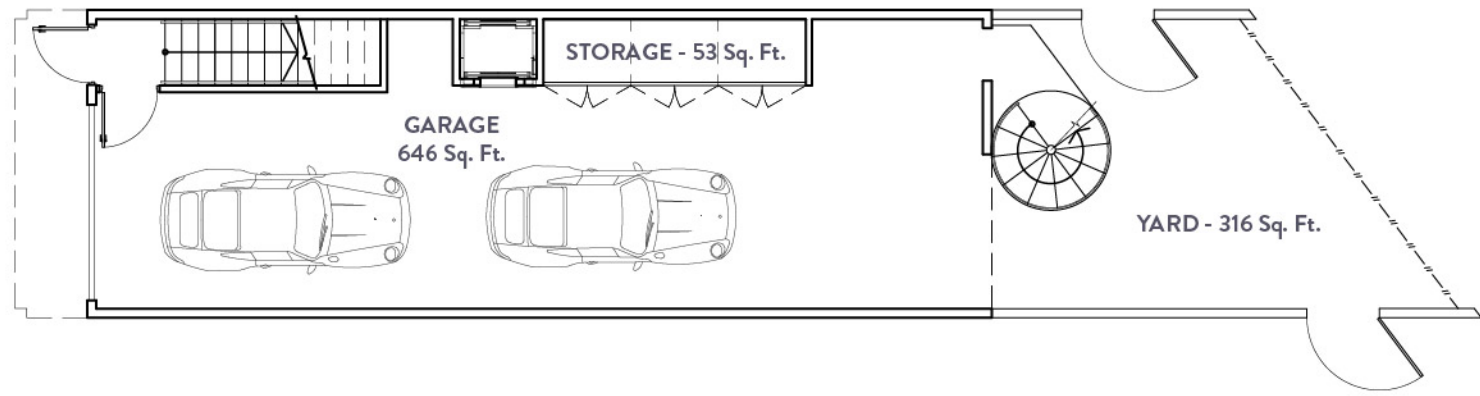

**LEVEL 0**



**LEVEL 1**

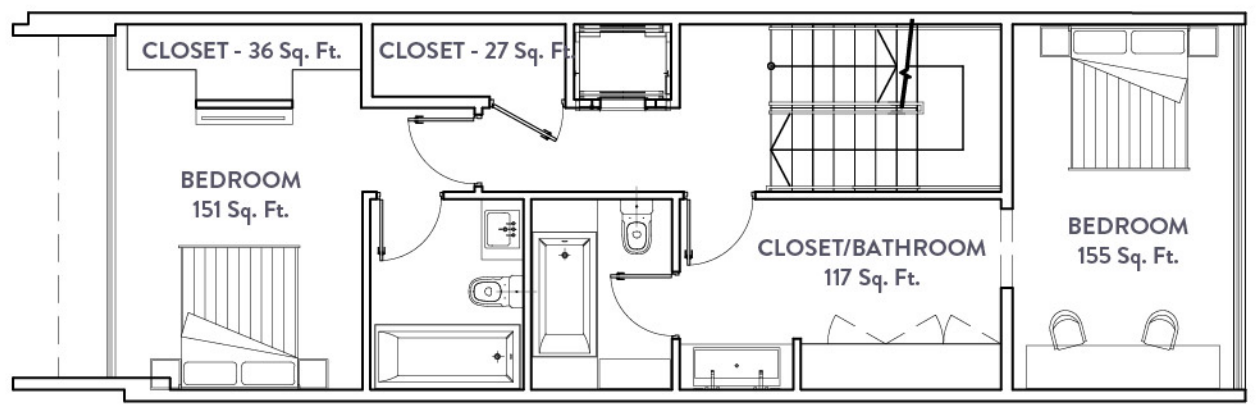

**LEVEL 2**

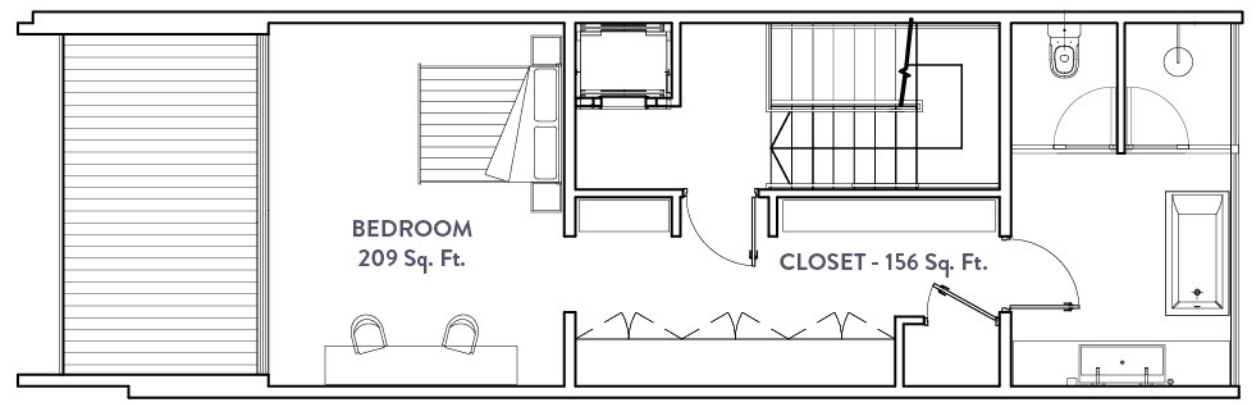

**LEVEL 3**

UNIT	BEDROOM	BATH	GARAGE	AIR CONDITIONED	1ST FLOOR TERRACE	3RD FLOOR BALCONY	TOTAL AREA	BACKYARD
3	3	4	830 Sq. Ft.	2.310 Sq. Ft.	130 Sq. Ft.	140 Sq. Ft.	3.410 Sq. Ft.	210 Sq. Ft.
5	3	4	830 Sq. Ft.	2.310 Sq. Ft.	130 Sq. Ft.	140 Sq. Ft.	3.410 Sq. Ft.	65 Sq. Ft.
7	3	4	830 Sq. Ft.	2.300 Sq. Ft.	130 Sq. Ft.	140 Sq. Ft.	3.400 Sq. Ft.	420 Sq. Ft.



**92  
01**  
WEST

**UNIT 4 & 6**

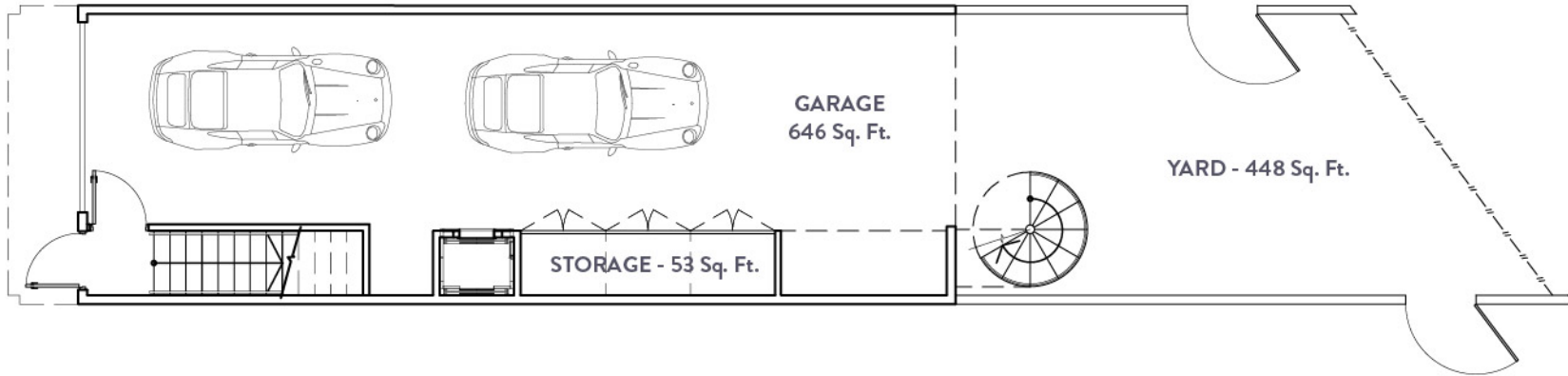

**LEVEL 0**



**LEVEL 1**

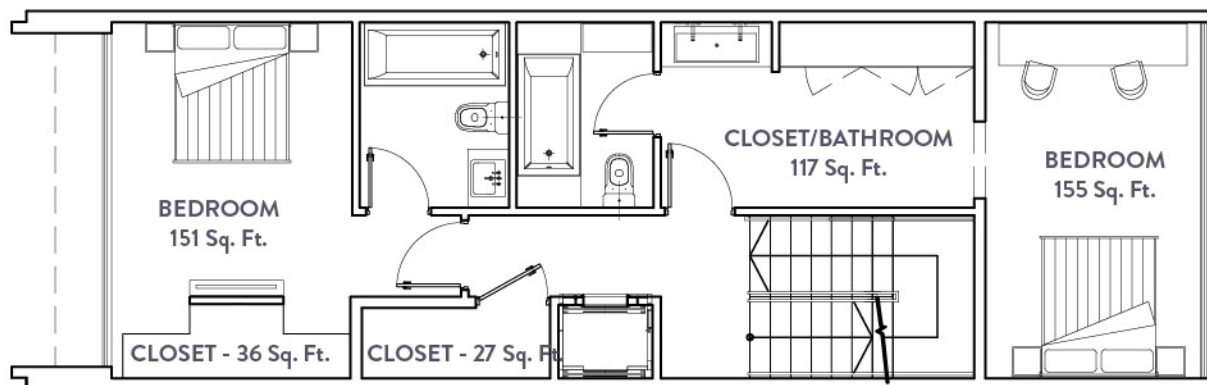

**LEVEL 2**



**LEVEL 3**

UNIT	BEDROOM	BATH	GARAGE	AIR CONDITIONED	1ST FLOOR TERRACE	3RD FLOOR BALCONY	TOTAL AREA	BACKYARD
4	3	4	830 Sq. Ft.	2,310 Sq. Ft.	130 Sq. Ft.	140 Sq. Ft.	3,410 Sq. Ft.	450 Sq. Ft.
6	3	4	830 Sq. Ft.	2,310 Sq. Ft.	130 Sq. Ft.	140 Sq. Ft.	3,410 Sq. Ft.	760 Sq. Ft.



92  
01  
WEST

UNIT 8

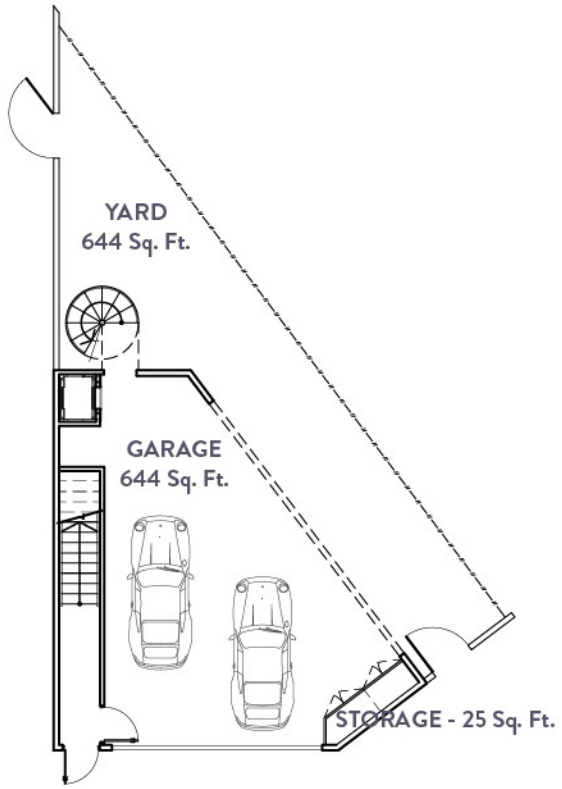

LEVEL 0

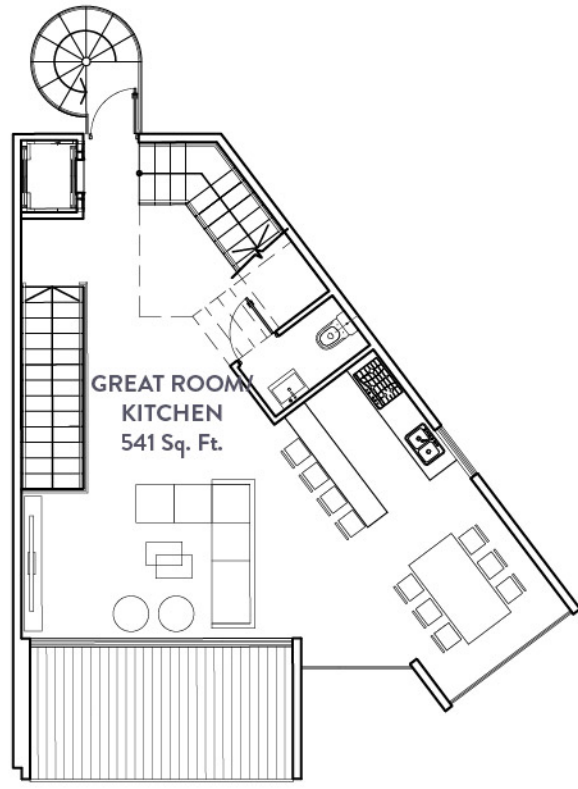

LEVEL 1

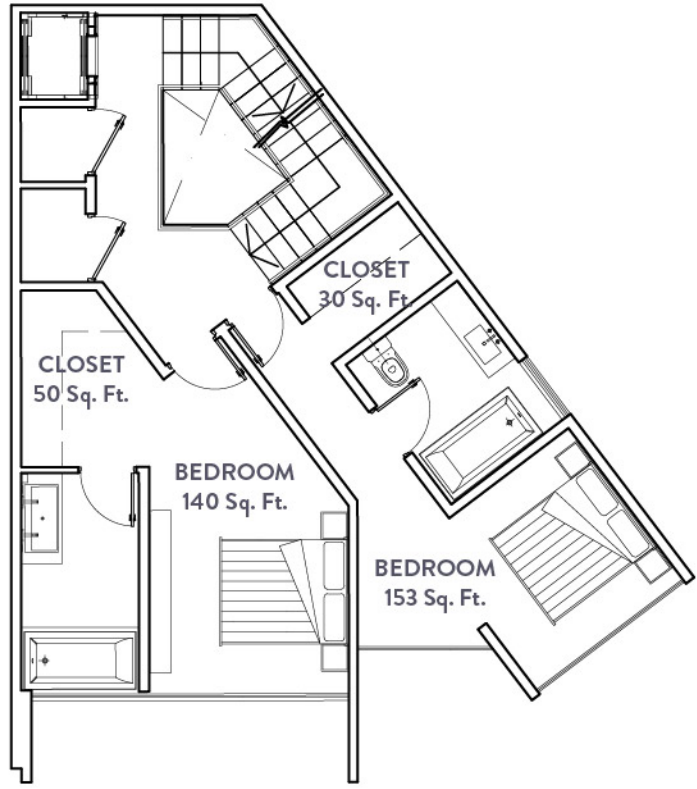

LEVEL 2

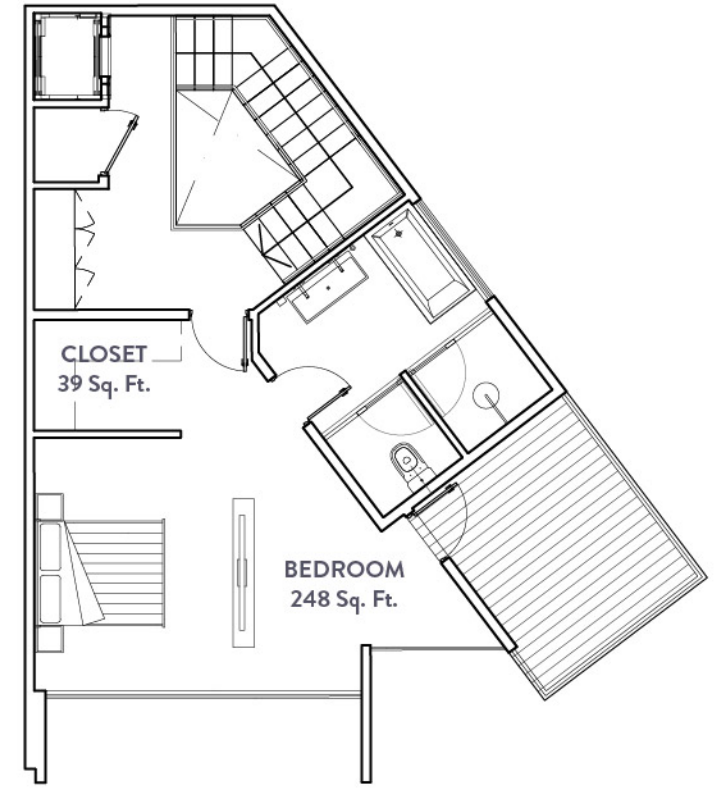

LEVEL 3

UNIT	BEDROOM	BATH	GARAGE	AIR CONDITIONED	1ST FLOOR TERRACE	3RD FLOOR BALCONY	TOTAL AREA	BACKYARD
8	3	4	810 Sq. Ft.	2,210 Sq. Ft.	130 Sq. Ft.	110 Sq. Ft.	3,260 Sq. Ft.	670 Sq. Ft.

# SITE PLAN

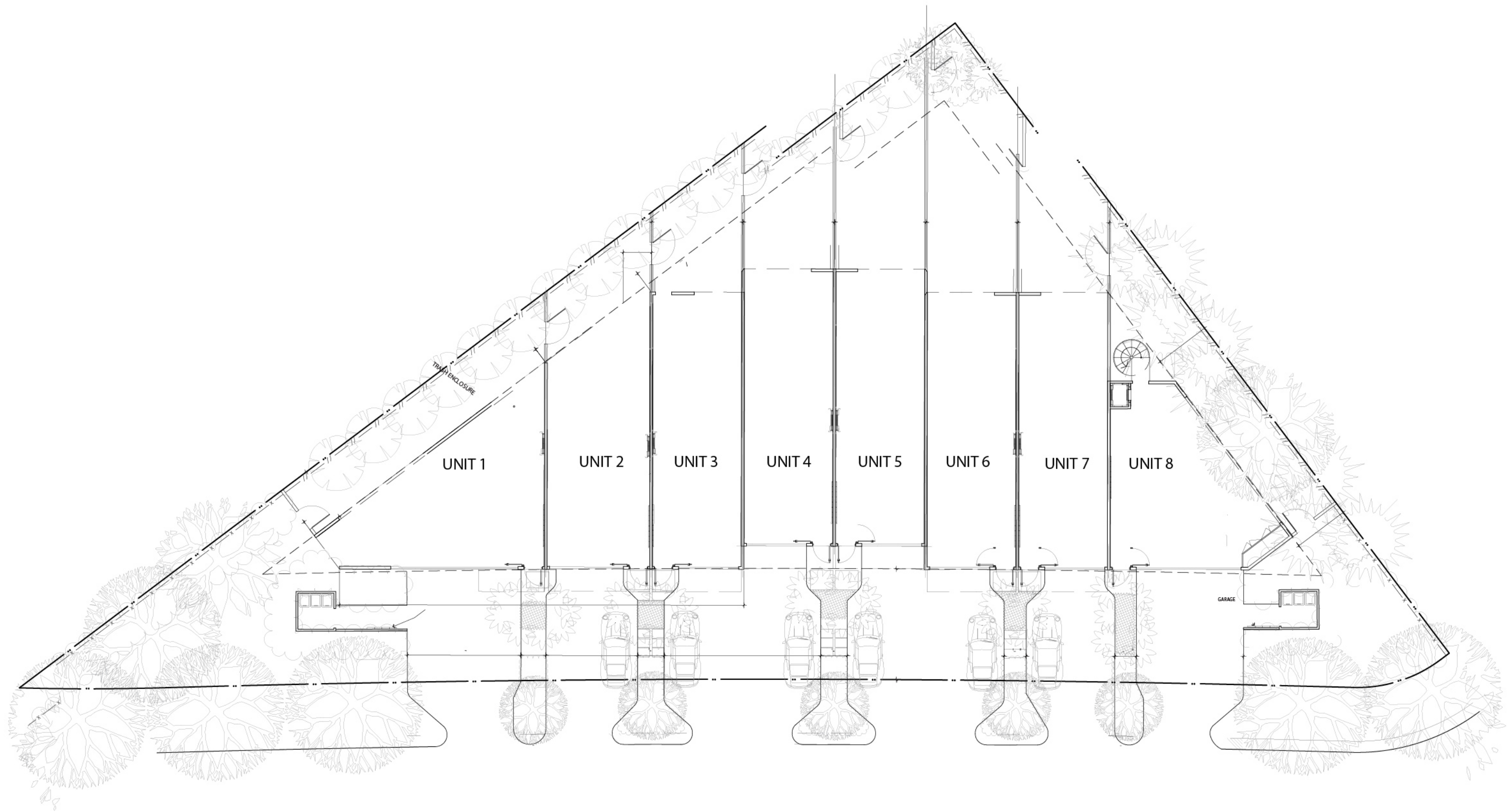

W. BAY HARBOR DRIVE